

Models:

- G4-18/20PA-SS
- G4-18/20A-SS
- G4-24PA-SS
- G4-24A-SS
- G4-30PA-SS
- G4-30A-SS



Certified to:

- ANSI Z21.60b
(CSA 2.26b)
- ANSI Z21.97 Draft D
- CAN1-2.21-M85

Regulated burner system for use with propane and natural gas

G4 STAINLESS STEEL BURNER FOR INDOOR OR OUTDOOR USE

Important: Read this manual carefully before starting installation of the log set.

WARNING

If the information in this manual is not followed exactly, a fire or explosion may result, causing property damage, personal injury, or loss of life.

Do not store or use gasoline or other flammable vapors and liquids in the vicinity of this or any other appliance.

An LP-cylinder shall not be stored in the vicinity of this or any other appliance.

WHAT TO DO IF YOU SMELL GAS:

- Do not try to light any appliance.
- Do not touch any electrical switch; do not use any phone in the building.
- Immediately call the gas supplier from a neighbor's phone and follow the gas supplier's instructions.
- If you cannot reach the gas supplier, call the fire department.

Installation and service must be performed by an NFI Certified or other qualified professional installer, service agency, or the gas supplier.

The installation of appliances designed for manufactured home (U.S. only) or mobile home installation must conform with the Standard CAN/CSA Z240 MH, Mobile Housing, in Canada, or with the Manufactured Home Construction and Safety Standard, Title 24 CFR, Part 3280, in the United States, or when such a standard is not applicable, ANSI/NCSCBS A225.1/NFPA 501A, Manufactured Home Installations Standard.

CODE AND SUPPLY REQUIREMENTS

The installation and the provisions for combustion and ventilation air must conform with local codes and ordinances, or in the absence of local codes, with the latest *National Fuel Gas Code, ANSI Z223.1/NFPA 54*, the *Natural Gas and Propane Installation Code, CSA B149.1*, or *International Fuel Gas Code*.

⚠ WARNING

Improper installation, adjustment, alteration, service, or maintenance can cause injury or property damage. Read the installation, operating and maintenance instructions thoroughly before installing or servicing this equipment.

This appliance is designed as an **attended appliance**. Adults **must** be present when the unit is operating. **DO NOT** leave this unit burning when unattended. If this product is left burning unattended it may cause damage or serious injury.

INSTALLER: Leave this manual with the appliance.
CONSUMER: Retain this manual for future reference.



Modèles:

**G4-18/20PA-SS
 G4-18/20A-SS
 G4-24PA-SS
 G4-24A-SS
 G4-30PA-SS
 G4-30A-SS**



Certifié à:

**ANSI Z21.60b
 (CSA 2.26b)
 ANSI Z21.97 Draft D
 CAN1-2.21-M85
 Système réglé de
 brûleur pour l'usage
 avec du propane et
 le gaz naturel**

BRÛLEUR À L'ACIER INOXYDABLE G4 POUR L'USAGE D'INTÉRIEUR OU EXTÉRIEUR

Lisez ce manuel soigneusement avant de commencer l'installation de l'ensemble de notation.

AVERTISSEMENT

Si l'information en ce manuel n'est pas suivie exactement, une incendie ou une explosion peut résulter, entraînant des dégâts matériels, le dommage corporel, ou des pertes humaines.

Ne stockez pas ou n'employez l'essence ou d'autres vapeurs et liquides inflammables à proximité de ceci ou d'aucun autre appareil.

Un LP-cylindre ne sera stocké à proximité de ceci ou d'aucun autre appareil.

CE QUI À FAIRE SI VOUS SENTEZ LE GAZ:

- **N'essayez pas de n'allumer aucun appareil.**
- **Ne touchez aucun commutateur électrique ; n'utilisez aucun téléphone dans le bâtiment.**
- **Appelez immédiatement le fournisseur de gaz du téléphone d'un voisin et suivez les instructions du fournisseur de gaz.**
- **Si vous ne pouvez pas atteindre le fournisseur de gaz, appelez les corps de sapeurs-pompiers.**

L'installation et le service doivent être assurés par un NFI certifié ou tout autre installateur professionnel qualifié, agence de service, ou le fournisseur de gaz.

L'installation des appareils conçus pour la maison manufacturée (États-Unis seulement) ou l'installation de caravane résidentielle doit se conformer au CAN/CSA standard Z240 MH, logement mobile, au Canada, ou à la construction et au standard de sécurité à la maison manufacturés, intitulent 24 CFR, la partie 3280, aux États-Unis, ou quand une telle norme ne s'applique pas, à ANSI/NCSBCS A225.1/NFPA 501A, installations à la maison manufacturées standard.

CODEZ ET FOURNISSEZ LES CONDITIONS

Ce brûleur extérieur doit être installé selon des codes locaux et des ordonnances, ou en l'absence des codes locaux, avec le plus défunt code national de gaz de carburant, la norme ANSI Z223.1/NFPA 54, le code d'installation de gaz naturel et de propane, CSA B149.1, ou code international de gaz de carburant.

⚠ AVERTISSEMENT

L'installation, l'ajustement, le changement, le service, ou l'entretien inexact peuvent causer des dommages ou des dégâts matériels. Lisez l'installation, l'opération et les instructions d'entretien complètement avant d'installer ou entretenir cet équipement.

Cet appareil est conçu comme appareil occupé. Les adultes doivent être présent quand l'unité fonctionne. Ne laissez pas ce burning d'unité si sans surveillance. Si ce produit est laissé sans surveillance brûlant il peut causer des dommages ou des dommages sérieux.

INSTALLATEUR: Laissez ce manuel avec l'appareil.

CONSOMMATEUR: Maintenez pour la future référence.



TABLE OF CONTENTS

SAFETY INFORMATION	3
PARTS LIST	4
BEFORE YOU BEGIN - IMPORTANT INFORMATION	5
INSTALLING THE DAMPER CLAMP	6
INSTALLATION	6
NOTES PAGE	8
LOG PLACEMENT	9
CHARRED SERIES SUPPLEMENTAL INSTRUCTIONS	10
OPERATING THE LOG SET - LIGHTING AND EXTINGUISHING	11
TECHNICAL DATA AND SPECIFICATION INFORMATION	13
TROUBLESHOOTING THE GAS LOG SET	14
WARRANTY	16

SAFETY INFORMATION

1. Children and adults should be alerted to the hazards of high surface temperatures and should stay away to avoid burns or clothing ignition.
2. Young children should be carefully supervised when they are in the area of the appliance.
3. Clothing or other flammable materials should not be placed on or near the appliance.
4. Any guard or other protective device removed for servicing the appliance must be replaced prior to operating the appliance.
5. Installation and repair must be done by a qualified service person. The appliance must be inspected before use and at least annually by a qualified service person. More frequent cleaning may be required as necessary.
6. Solid fuels shall not be burned in a fireplace where this gas log set is installed.
7. Keep the appliance area clear and free from combustible materials, gasoline and other flammable vapors and liquids.
8. The burner assembly must be replaced prior to the appliance being put into operation if it is evident that the burner assembly is damaged. Contact your local dealer for replacement parts.
9. A fireplace screen must be in place when the system is burning. Provisions for adequate combustion air must be maintained. Unless other provisions for combustion air are provided, the screen shall have an opening(s) for introduction of combustion air. Combustion air is adequate when all flames curl into the fireplace and away from the screen. When a glass fireplace enclosure (door) is used, leave the doors fully open when the system is in operation.

PARTS LIST

Before beginning installation, be sure the gas log set is complete by comparing its contents with this PARTS LIST. The Golden Oak log set is listed and illustrated. The parts may differ depending upon the log style and size of the set. Be sure you know the model number and size of your set when ordering replacement or optional parts and accessories.

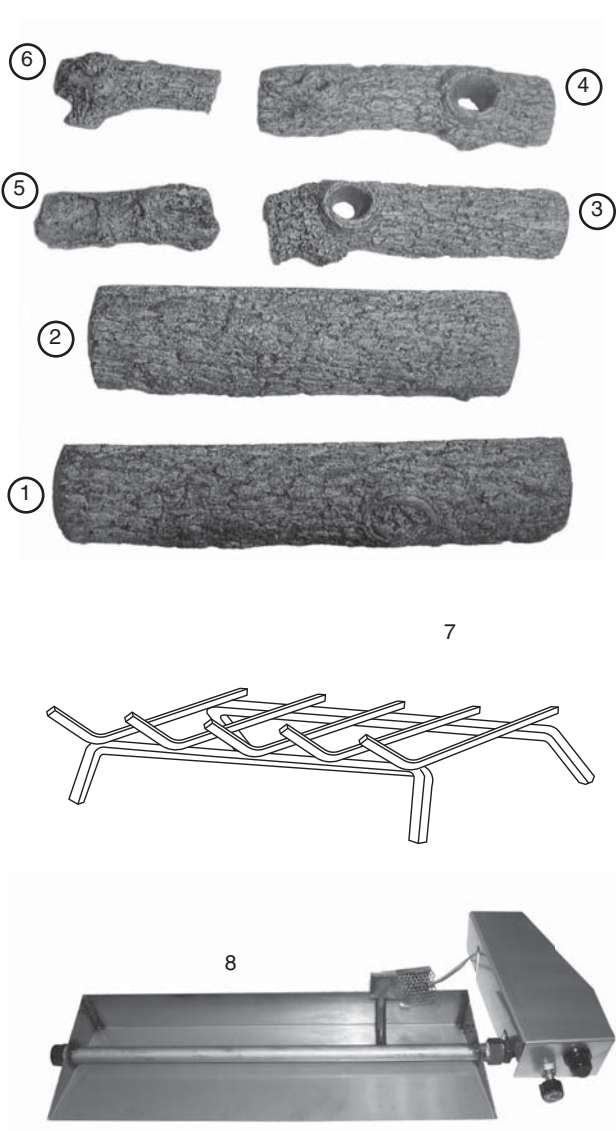

Replacement parts can be ordered from your local dealer.



ITEM#	DESCRIPTION
1.	Golden Oak front bottom log
2.	Golden Oak Rear bottom log
3.	Golden Oak top log
4.	Golden Oak top log
5.	Golden Oak top log
6.	Golden Oak top log
7.	Fireplace grate

ITEM#	DESCRIPTION
8.	Burner pan and valve assembly
9.	Connector kit
10.	Real-Fyre® glowing embers
11.	Lava granules
12.	Damper clamp
13.	(2) Stabilizer clips

BEFORE YOU BEGIN - IMPORTANT INFORMATION

Before You Begin, review the information and safeguards below about the installation and operation of the Real-Fyre® gas log set.

Check to be sure that the fireplace meets the venting and construction requirements for the installation of the Real-Fyre® gas log set.

THIS BURNER IS DESIGNED FOR USE WITH PROPANE OR NATURAL GAS. Never use natural gas in a log set designed for use with propane gas and never use propane gas in a burner designed for natural gas.

This product is not recommended for use in temperatures below 32°F.

Be sure the gas log set is properly sized for the fireplace. Improper sizing may negatively impact the proper drafting of the fireplace. Additionally, too large a log set will adversely affect the burn and hamper the proper operation of the control system. Too small a log set will diminish the beauty of the hearth setting. Fig. 5-1 illustrates the critical dimensions of the firebox.

This gas log set must be installed by an NFI Certified or other qualified professional installer. The Real-Fyre® gas log set is to be installed only in a solid-fuel burning fireplace with a working flue and constructed of noncombustible material. The fireplace must have an open damper. The chimney must be free of any obstructions. The fireplace flue must be at least 8" at its smallest dimension.

The fireplace must have a gas supply line that has been installed by a qualified technician in accordance

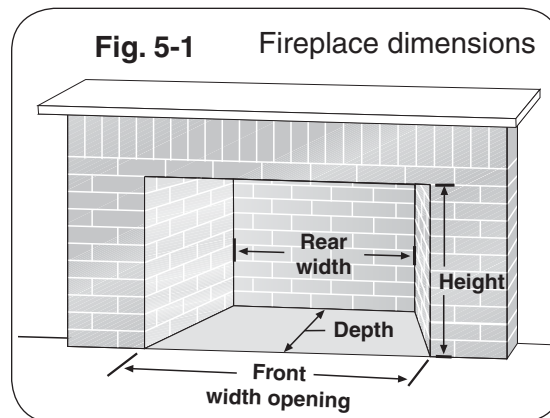

with all local codes. The gas supply line must have a ½" minimum interior diameter. If the gas line to the fireplace is longer than 20', a larger diameter line may be necessary.

Be sure to clean the fireplace floor of any ashes or other foreign materials. It is recommended that the fireplace and chimney be examined and cleaned by a chimney sweep or other qualified person before you install the Real-Fyre® gas log set, and annually thereafter.

Required Gas Pressure: The minimum inlet gas-supply pressure for the purpose of input adjustment is 5" for natural gas and 10" for propane gas. The maximum inlet gas-supply pressure for this burner is 10.5" for natural gas and 13" for propane gas.

Testing the Gas Supply System: The gas log set and its individual shut-off valve must be disconnected from the gas supply piping system while performing any tests of the piping system at pressures in excess of ½ psig (3.5 kPa). The gas log set must be isolated from the gas supply piping system by closing its individual manual shut-off valve during any pressure testing of the gas supply piping system at test pressures equal to or less than ½ psig (3.5 kPa). This is accomplished by closing the gas supply line valve, which is required by NFPA 54, section 5.54.

Burner size	Min. Fireplace Dimensions				BTU	
	Width		Depth	Height	NAT.	L.P.
	Front*	Rear				
18/20"	24"	20"	12"	18"	75M	45M
24"	28"	26"	12"	18"	95M	65M
30"	36"	32"	12"	18"	98M	65M

MINIMUM FREE OPENING AREA OF CHIMNEY DAMPER FOR VENTING						
For Factory Built Fireplaces Log Set Sizes				For Masonry Built Fireplaces Log Set Sizes		
Chimney Height	18/20"	24"	30"	18/20"	24"	30"
15'	47 sq. in.	60 sq. in.	62 sq. in.	51 sq. in.	64 sq. in.	66 sq. in.
20'	43 sq. in.	54 sq. in.	56 sq. in.	47 sq. in.	58 sq. in.	60 sq. in.
25'	41 sq. in.	51 sq. in.	53 sq. in.	45 sq. in.	55 sq. in.	57 sq. in.
30'	38 sq. in.	48 sq. in.	50 sq. in.	42 sq. in.	52 sq. in.	54 sq. in.

* An additional 4" is recommended to center the log set.

Note: Rear width is at corresponding depth.

Important: For safe operation and proper performance of this product and to comply with certification, listings, and building code acceptances, use ONLY Peterson Real-Fyre® controls, parts, and accessories that have been specifically listed or certified for use with this burner system. Use of other controls, parts, or accessories is prohibited and will void all warranties, certifications, listings, and building code approvals, and may cause property damage, personal injury, and loss of life.

INSTALLING THE DAMPER CLAMP

A damper clamp is provided as a means to prevent full and/or accidental closure of the fireplace damper when installed as illustrated (Fig. 6-2). When the gas log set is operating, the damper must be fully open. To install the damper clamp:

1. Open the fireplace damper.
2. Place the damper clamp over the damper blade (Fig. 6-2).
3. Tighten the set screw of the damper clamp with pliers or a wrench so that it affixes to the damper blade. The clamp must be permanently installed.

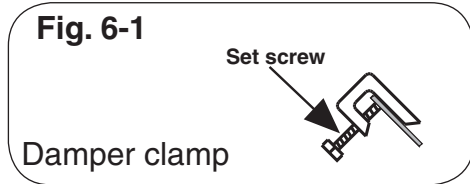

4. Should the damper clamp not fit, install a permanent damper stop or provide some other means of preventing full and/or accidental closure of the damper.

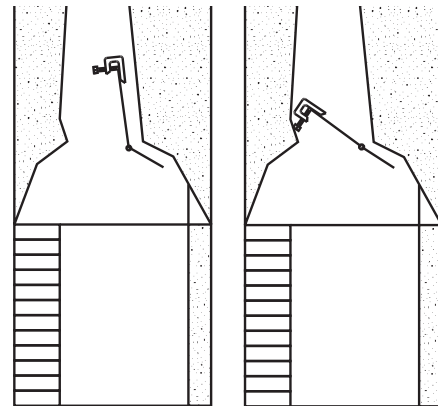

Fig. 6-2

INSTALLATION

Refer to the **PARTS LIST** when installing the Real-Fyre® gas log set

WARNING: Failure to position the parts in accordance with these diagrams or failure to use only parts specifically approved with this appliance may result in property damage or personal injury.

1. Carefully unpack the burner system. Check the **PARTS LIST** to be sure all parts are included.
2. **Check to be sure that the Real-Fyre® gas log set is designed for the type of gas that fuels the fireplace.**
3. Be sure the gas supply to the fireplace is turned off.
4. Clean the fireplace floor of any dirt or ashes.
5. Remove the cap from the gas supply line stub in the fireplace (Fig. 6-3).

Caution: Be sure that when removing the cap, the stub does not turn, loosening the connection inside the wall.

PLACEMENT OF GRATE AND BURNER

The Real-Fyre® grate is modeled after wood-fire grates to add to the natural wood-fire appearance of the log set. Its heavy duty construction and design provides a better fit - even in narrow, shallow fireboxes - and works with the log set to provide an attractive flame pattern.

To position the Real-Fyre® gas log set properly in the fireplace, place the grate as far back in the fireplace as possible, centered left-to-right (Fig. 6-4). The grate is tapered. The widest side should face forward.

Fig. 6-3

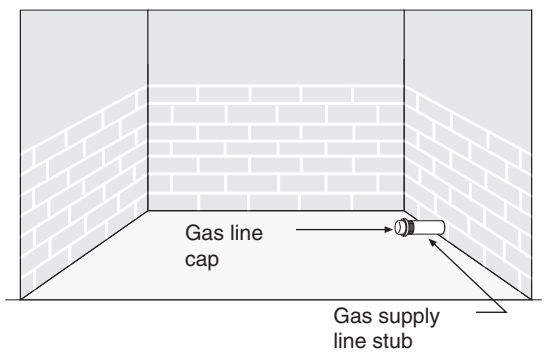

Install the stabilizer clips on the grate bars so that the slots of the stabilizer clips fit over the back edge of the burner pan. Use the nuts and bolts provided to secure the clips in position.

Remove grate for gas connection and granule/ember placement.

Fig. 6-4

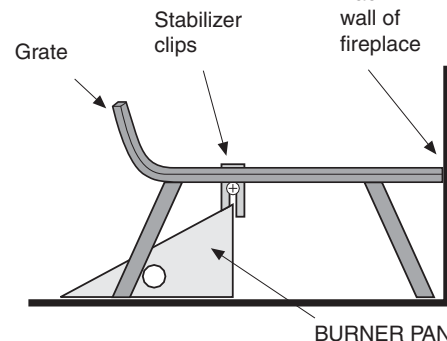

CONNECTING THE GAS SUPPLY

1. The burner pan is supplied with an **air mixer** for propane gas or a fuel injector for natural gas. **The air mixer or fuel injector must be used in ALL installations.** The air mixer/fuel injector has a precisely sized orifice to ensure only the proper quantity of gas enters the burner. This allows maximum performance and gas conservation.
2. When installing the log set, **use Teflon tape or pipe compound resistant to the action of propane gas on all threaded male connections except brass to brass connections.**
3. **Installing the gas log set (see Fig. 7-1)**
 - a. Attach the large adapter (Item 9a) to the gas supply stub in the fireplace. Use Teflon tape or pipe compound on the stub. Tighten securely. Connect the tubing to the adapter.
 - b. Discard the small adapter (Item 9c). Connect the tubing to the elbow found on the regulator. Tighten both ends securely.
 - c. **Be sure to turn off the valve** and then turn on the gas supply to the fireplace.
 - d. Test for leaks at all connections with a soapy water solution. **Never use an open flame to check for leaks.**
 - e. Turn off gas supply.
 - f. Proceed to GRANULE PLACEMENT.

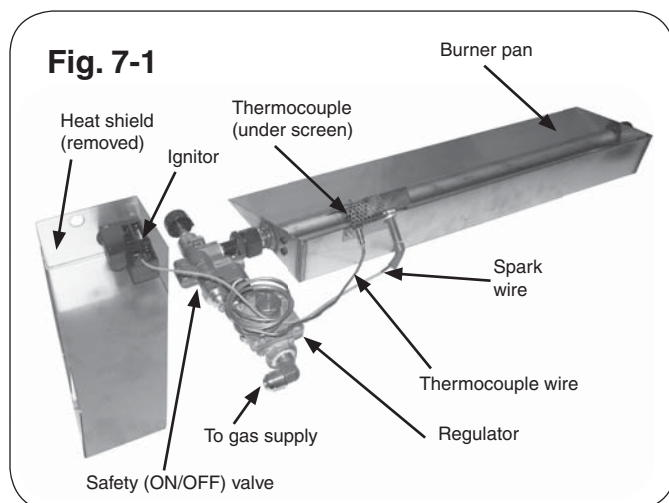

GRANULE PLACEMENT

The granules supplied with the unit are specially selected for use with either propane gas or natural gas. They maximize flame distribution and reduce carbon buildup.

1. With the burner pan off and properly positioned in the fireplace, fill the burner pan completely with the granules. **Avoid spilling the granules on the Peterson control, if one is in place.**
2. Slope the granules at the same angle as the burner pan. This is important to ensure quiet lighting and even flame distribution.
3. Pour a small amount of the granules along the outside bottom edges and back of the burner pan (Fig. 7-2). This prevents flame diversion.

Fig. 7-2

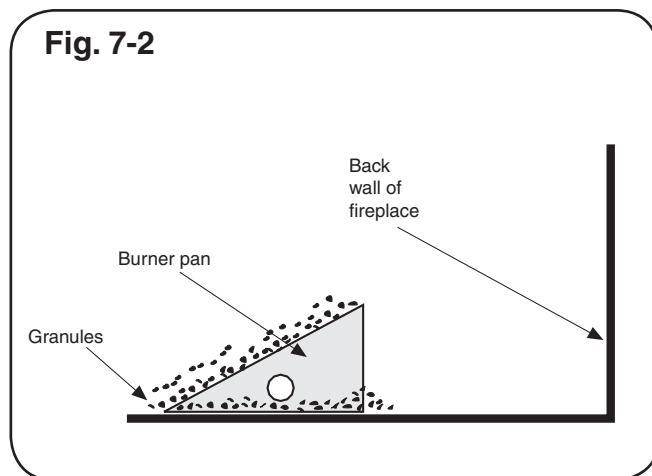

GLOWING EMBERS PLACEMENT

Real-Fyre® glowing embers are specially formulated and sized to create the most authentic, uniform glow, duplicating red hot coals under the grate. They are a major element in the beautiful realism of Real-Fyre® gas log sets. All materials used are nonflammable and inert, containing no asbestos.

1. Sprinkle the Real-Fyre® glowing embers lightly and evenly over the entire surface of the granules (Fig. 7-2). For Charred series log sets see page 10.

GRATE REPLACEMENT

1. Reposition the grate in the fireplace over the burner pan. Make sure the stabilizer clips slide over the back edge of the burner pan.

LOG PLACEMENT

The beauty and design of the Real-Fyre® gas logs are the result of skilled craftsmanship, research, and engineering. The fine quality materials used to mold the logs are formulated from kiln-fired ceramics, superior refractories and the best expanded shales and aggregates, exactly proportioned. Added to this material are steel reinforcing rods, precisely sized and designed to prevent breakage. This creates realistic, long-lasting logs. Their durability has been proven by over a half century of use in family homes. Real-Fyre® logs are guaranteed for as long as you own them. Hairline cracks are common and may appear after the first use. This will not affect the integrity of the logs or the operation.

Each log is skillfully designed and crafted to duplicate natural wood. Deep, rugged bark textures and hand-painted highlighting challenges the viewer to tell whether they are looking at real wood logs or Real-Fyre® logs. Knotholes, branch stubs, and peeled-away bark in many styles also add to the realism of the Real-Fyre® gas log set.

DESIGNER AND CLASSIC SERIES LOG PLACEMENT

(For Charred series log sets see page 10).

1. **Log placement is very important for the proper operation and performance of the Real-Fyre® gas log set.** Although you have some flexibility in the log arrangement, it is necessary to follow the log placement instructions carefully to fully enjoy the log set.
2. The longest log is placed on the front of the grate with the bark of the log facing forward. If you have a heat chamber built into the log style, it should be facing the rear of the fireplace (Fig. 9-1).
3. The second longest log (Item 2) is placed on the rear of the grate with the bark of the log facing forward. If you have a heat chamber built into the log style, it can face forward or to the rear of the fireplace as you desire.

Fig. 9-1

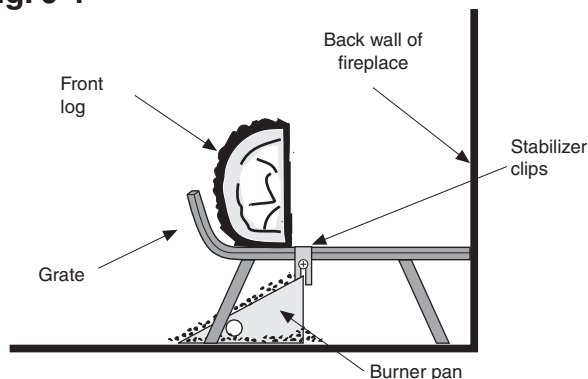

Be sure to provide a minimum of 3" between the front and rear log (Fig. 9-2). This will create the energy efficiency and heat radiating effect of the log set and will also reduce carbon buildup.

Fig. 9-2

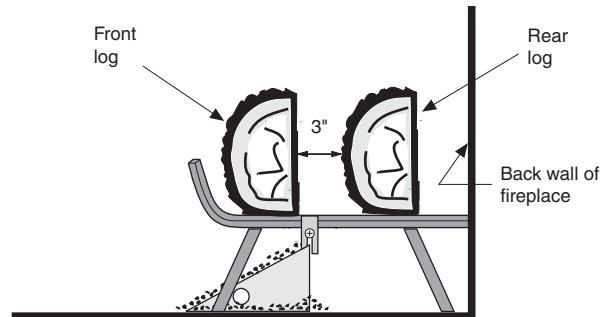

4. Top logs should be placed diagonally with space between the logs so that the flames are not choked off. Top logs may be moved to achieve the desired flame pattern. Some carbon buildup (sooting) may be observed where the flames impinge on the logs. Unless the sooting is excessive, this should not be a concern. If sooting is excessive, rearrange the top logs so there is less flame impingement. Examples of log stacks are shown in Fig. 9-3.

Fig. 9-3

Woodland Oak

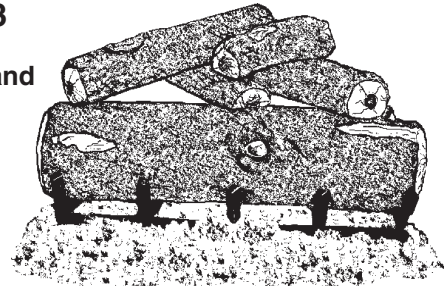

Split Oak Designer Plus

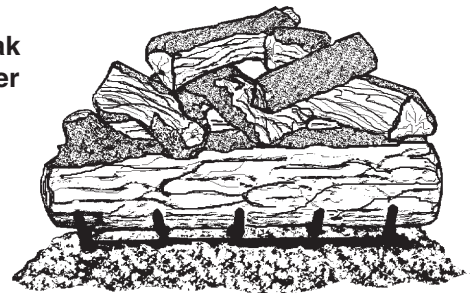

Royal English Oak Designer

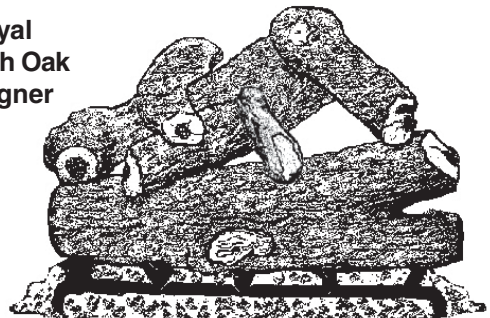

CHARRED SERIES SUPPLEMENTAL INSTRUCTIONS

These instructions must be used with the Charred series gas log set series

EMBER COALS PLACEMENT

Attach the ember bed to the burner by slipping it onto the back edge (center left to right) with the perforated section facing towards the back fireplace wall.

Cover the surface of the ember bed with the ember coals (Fig. 10-1). For best glowing performance, they should be applied evenly and pulled slightly apart so the fibers are somewhat loose. (It is not necessary to pile the entire bag of the ember coals. More ember coals may be added after completion of the entire installation.)

GRATE REPLACEMENT

Follow the instructions on page 7.

Fig. 10-1

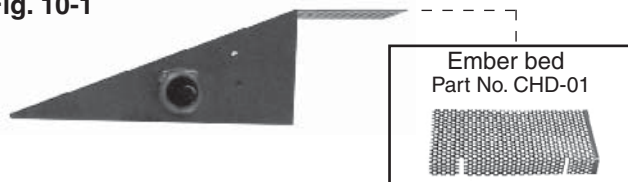

Fig. 10-1a



Note: Ember bed(CHD-01) included with Charred Series log sets only.

CAUTION: Burn hazard. Logs will remain hot for some time after use.

YOU MUST MAINTAIN THE LOG LAYOUT AS SHOWN TO ENSURE PROPER OPERATION OF THE LOG SET. IF YOU NEED TO REPOSITION ANY LOG TO MAINTAIN THE PROPER LAYOUT, USE HEAT RESISTANT GLOVES OR ALLOW LOGS ADEQUATE TIME TO COOL BEFORE HANDLING.

CHARRED SERIES LOG PLACEMENT

Place the long bottom rear log (Log #2) on the back of the grate with the flat hollow side facing the rear of the fireplace. The two sections of the front log (Logs #1A & 1B) are placed on the front of the grate with the charred sections facing each other and positioned approximately 1" apart at the top (Fig. 10-2). There should be 3" between the front and rear logs.

Place the two top knothole logs (Logs #3 & 4) so that one end rests on each front log (Logs #1A & 1B) and the other end on the rear log (Log #2). The charred sections should be over the opening between the front and rear logs (Fig. 10-3).

Place the small top charred log (Log #5) between the knothole logs so it rests on the rear log (Log #2) and the right-hand front log (Log #1B) with the charred section facing the front (Fig. 10-4).

Place the curved top charred log (Log #6) so the charred section rests on the left-hand front log (Log #1A) and the other end rests on the middle of the right top knothole log (Log #4); see Fig. 10-5.

Place the additional top log (Log #7) on the top in the desired position. *Additional log not available with 18" log set.*

** Other options may be chosen for top log placement.*

Light the log set, referring to installation instructions for procedures. More ember coals may be placed on the ember bed for the added realism of a burning-wood look.

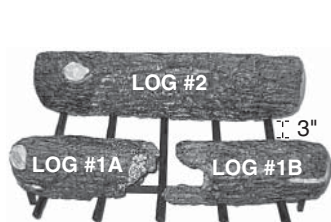

Fig. 10-2



Fig. 10-3

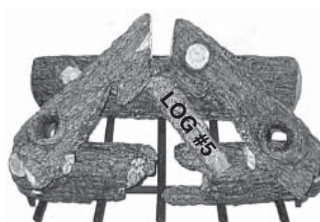

Fig. 10-4



Fig. 10-5

Note: Charred Oak (CHD) log set used for illustration.

OPERATING THE LOG SET - LIGHTING AND EXTINGUISHING

FOR YOUR SAFETY, READ BEFORE LIGHTING

WARNING: If you do not follow these instructions exactly, a fire or explosion may result, causing property damage, personal injury, or loss of life.

- A. BEFORE LIGHTING**, smell all around the gas log set area for gas. Be sure to smell next to the floor because some gas is heavier than air and will settle on the floor.
- B. IF YOU SMELL GAS:**
- **Shut off the gas to the appliance.**
 - **Extinguish any open flame.**
 - **If odor continues, keep away from the appliance, and immediately call the gas supplier or fire department.**
- C.** Use only your hand to push in or turn the gas control knob. Never use tools. If the knob will not push in or turn by hand, don't try to repair it. Call a qualified service technician. Force or attempted repair may result in fire or explosion.
- D.** Do not use the gas log set if any part has been underwater. Immediately call a qualified service technician to inspect the gas log set and to replace any part of the control system and any gas control that has been underwater.

LIGHTING THE GAS LOG SET

1. After you have finished checking for leaks, ensure that the unit is turned completely off by pushing in the ON/OFF control knob and turning clockwise toward **OFF** until you reach a stop.
2. Turn the ON/OFF control knob counter-clockwise to the **ON** position. **DO NOT PUSH KNOB IN!**

Note: You should not hear or smell any gas at this point.

3. Wait five (5) minutes to clear out any gas. Smell for gas, including near the floor. If you smell gas, stop and follow step B of the safety information above. If you don't smell gas, go to the next step.

4. LIGHTING INSTRUCTIONS

- a. Press and hold in the electronic ignitor button. The ignitor will spark with a rapid clicking noise.
- b. While holding in the electronic ignitor, push in the ON/OFF control knob to open the valve. Burner will now ignite at the maximum BTU input.
- c. Continue to hold knob for 10-15 seconds; this will allow the safety valve to activate and the main burner to remain burning.

Note: Electronic igniter may not properly operate when exposed to high moisture. To manually light the burner, lay a long-stem match on the surface of the embers near the gas inlet (**do not hold the match in your hand**) or use a lighted long necked butane lighter.

TURNING OFF THE GAS LOG SET

1. Push in the ON/OFF control knob and turn clockwise toward **OFF** until you reach a stop (burner will extinguish).

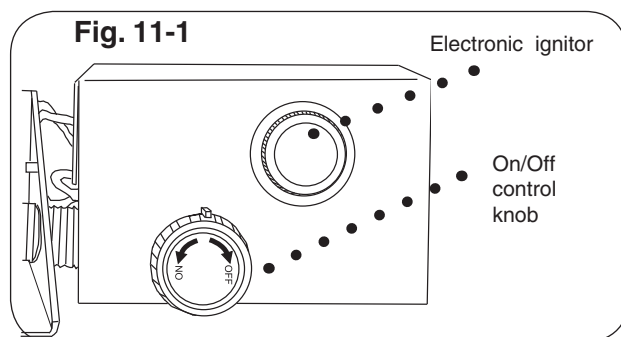

POUR VOTRE SÛRETÉ, LISEZ AVANT L'ALLUMAGE

AVERTISSEMENT: Si vous ne suivez pas ces instructions exactement, une incendie ou une explosion peut résulter, entraînant des dégâts matériels, le dommage corporel, ou des pertes humaines.

- A. AVANT L'ALLUMAGE**, sentez tous autour du secteur réglé de notation de gaz pour le gaz. Soyez sûr de sentir à côté du plancher parce qu'un certain gaz est plus lourd que l'air et arrangez sur le plancher.
- B. SI VOUS SENTEZ LE GAZ:**
- Coupez le gaz à l'appareil
 - Éteignez-vous n'importe quelle flamme nue.
 - Si l'odeur continue, gardez à partir de l'appareil, et appelez immédiatement le fournisseur ou les corps de sapeurs-pompiers de gaz.
- C.** Utilisez seulement votre main pour enfoncer ou pour tourner le bouton de commande de gaz. N'utilisez jamais les outils. Si le bouton n'enfoncera pas ou ne tournera pas à la main, n'essayez pas de le réparer. Appelez un technicien qualifié de service. La force ou la réparation essayée peut avoir comme conséquence l'incendie ou l'explosion.
- D.** N'employez pas la notation de gaz réglée si n'importe quelle partie a été sous-marine. Appelez immédiatement un technicien qualifié de service pour inspecter l'ensemble de notation de gaz et pour remplacer n'importe quelle partie du système de contrôle et de n'importe quelle commande de gaz qui a été sous-marine.

ALLUMAGE DE L'ENSEMBLE DE NOTATION DE GAZ

1. Après que vous ayez fini la vérification les fuites, assurez-vous que l'unité est arrêtée complètement en enfonçant le bouton de commande "MARCHE/ARRÊT" et en tournant dans le sens des aiguilles d'une montre vers AU LOIN jusqu'à ce que vous atteigniez un arrêt.
2. Tournez le bouton de commande "MARCHE/ARRÊT" dans le sens contraire des aiguilles d'une montre à la position de fonctionnement. **NE PUSSEZ PAS LE BOUTON DEDANS!**

Note: Vous ne devriez entendre ou sentir aucun gaz en ce moment.

3. Attendez cinq (5) minutes pour dégager dehors n'importe quel gaz. Sentez pour le gaz, y compris près du plancher. Si vous sentez le gaz, arrêtez et suivez l'étape B d'information de sûreté ci-dessus. Si vous ne sentez pas le gaz, passez à la prochaine étape.

4. INSTRUCTIONS D'ÉCLAIRAGE

- a. Pressez et tenez dans le bouton électronique d'allumeur. L'allumeur étincellera avec un bruit cliquant sur rapide.
- b. Tout en se tenant dans l'allumeur électronique, enfoncez le bouton de commande "MARCHE/ARRÊT" pour ouvrir la valve. Le brûleur mettra à feu maintenant à l'entrée de Btu de maximum.
- c. Continuez à tenir le bouton pendant 10-15 secondes; ceci permettra à la soupape de sûreté d'activer et au brûleur principal de rester brûlant.

Note: La bougie électronique peut correctement ne pas fonctionner une fois exposée à l'humidité élevée. Pour allumer manuellement le brûleur, étendez une allumette de long-tige sur la surface des braises près de l'admission de gaz (ne tenez pas l'allumette dans votre main) ou employez un long allumeur étranglé allumé de butane.

ARRÊTER L'ENSEMBLE DE NOTATION DE GAZ

1. Enfoncez le bouton de commande "MARCHE/ARRÊT" et tournez dans le sens des aiguilles d'une montre vers AU LOIN jusqu'à ce que vous atteigniez un arrêt (le brûleur s'éteindra).

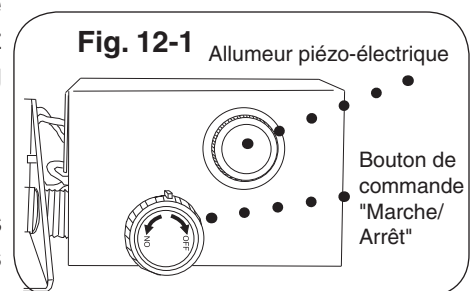

MAINTENANCE

Once installed and operating properly, the Real-Fyre® gas log set requires very little maintenance. You should inspect the log set and control annually for the following:

- 1. Excessive sooting** - Some sooting of the log set is normal and adds to the appearance of burned wood. If sooting accumulates, you may brush the soot off with a stiff brush. Do not use water or soot cleaners to clean off the soot.
- 2. Settling of glowing embers and granules** - Moisture may cause the granules and glowing embers in the burner pan to settle and affect the burn. Using a screwdriver or flat blade knife, carefully stir the granules and embers, loosening the materials.
- 3. Debris around the control** - Inspect the control to be sure it is free of any dirt or debris.

SERVICE

While some minor service conditions may be handled by the owner of the log set, it is recommended that a qualified service technician be called to service the gas log set and control should service be required. The TROUBLESHOOTING section of these instructions serves as a guide for ensuring optimum performance of the gas log set.

FLAME DESCRIPTION

Observe the flames. The main burner flames should be blue at the base and a combination of blue/yellow at the body and at the tips. They should be 5" to 8" above the logs, with the center flame being the tallest (see cover photo). Flames in the ember burner should be 1/4" above the embers.

To adjust the flame pattern, take a long blade screwdriver or similar tool and stir the granules until the desired pattern is achieved. **DO NOT REMOVE GRANULES FROM THE BURNER PAN**

Long bladed screwdriver
(or similar)

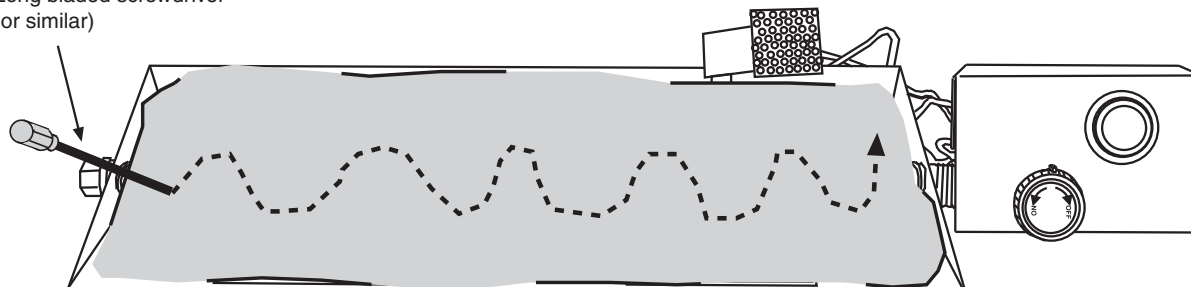

Insert blade into granules and stir in various places until desired flame pattern is achieved.

TROUBLESHOOTING THE GAS LOG SET

SYMPTOM	CAUSE	SOLUTION
<p>1. Excessive smoking and sooting</p> <p>Note: Like burning natural firewood, the Real-Fyre® gas log set is designed to burn with a yellow smoky flame. Some sooting is common and desirable.</p>	A. Poor draft or down draft	A. Check for chimney blockage. Be sure chimney is at least 3' taller than anything within 10' of it in all directions. If not, consult a chimney sweep. Chimney cap or fan may help. Under severe conditions, you may need to open a window near the fireplace about 1" to 2" when burning the log set.
	B. Improper set for gas used	B. Use only a natural gas set with natural gas. Use only a propane gas set with propane gas.
	C. Damper closed	C. Open damper fully when operating gas log set.
	D. Set is positioned too close to the front of the firebox	D. Move set so that the back of the grate touches the back wall of the firebox.
	E. Improper log placement	E. Be sure the bottom logs are spaced at least 3" apart. Top logs should be placed to minimize flame impingement.
	F. Flue is less than 8" in diameter	F. Remove the log set. Inadequate fireplace ventilation.
	G. Air mixer on propane set is closed	G. Open air mixer completely.
<p>2. Low flame</p>	A. Incorrect log set size for burner system	A. Consult the dealer for proper set.
	B. Insufficient gas supply	B. Other gas appliances may be competing for gas supply. Consult installer or plumber. Orifice size is based upon 7" w.c. pressure for natural gas and 11" w.c. pressure propane gas. Plumbing must supply adequate pressure.
	C. Blockage or kink in connector kit, plumbing or burner orifice	C. Clean out blockage. If connector kit is kinked, replace it.
	D. Valve not fully open	D. Open valve fully.

TROUBLESHOOTING THE GAS LOG SET (cont.)

SYMPTOM	CAUSE	SOLUTION
3. Uneven flame distribution (Lower at one end of the burner)	A. Clogged or blocked portholes	A. Portholes can be cleared of foreign object by running a wire through them.
	B. Insufficient gas pressure and/or supply	B. Consult installer or plumber (see solution 2b).
	C. Granules may be packed down too tightly or not evenly	C. Loosen granules around burner pipe by running a kitchen knife along both sides of pipe. Even out granules in burner pan.
	D. Auxiliary shut-off valve partially closed	D. Open valve fully. Usually, you will find this along the wall 3' from the fireplace.
	E. Valve not fully open	E. Open valve fully.
4. Flame backing out of air mixer (propane)	A. Clogged or blocked portholes	A. Portholes can be cleared of foreign object by running a wire through them.
	B. Insufficient gas pressure and/or supply	B. Consult installer or plumber (see solution 2b).
	C. Granules may be packed down too tightly	C. Loosen granules around the burner by running a kitchen knife along both sides of the pipe. Be sure lava granules are used.
	D. Excessive gas pressure	D. Contact the gas supplier.

WARRANTY

PETERSON VENTED GAS LOG SETS LIMITED WARRANTY

All Peterson gas logs are **WARRANTED for as long as you own them (lifetime)**.

All Peterson burner assemblies are **WARRANTED for TEN (10) YEARS**.

SPK-26 controls are covered by a **THREE (3) YEAR "All Parts" Warranty**.

All other Peterson valves, pilots, and controls are covered by a **ONE (1) YEAR Limited Warranty (excluding batteries)**.

PLEASE KEEP A COPY OF YOUR SALES SLIP FOR PROOF OF PURCHASE

This warranty applies to the original purchaser and to single family residential use only. It commences from date of purchase, and is valid only with proof of purchase.

This warranty does not cover parts becoming defective through misuse, accidental damage, electrical damage, improper handling, storage, and/or installation. Product must be installed (and gas must be connected) as specified in the instructions or operator's manual, by a **qualified professional installer**. Accessories, parts, valves, remotes, etc., when used must be Peterson Co. product.

This warranty **does not** apply to rust, corrosion, oxidation, or discoloration, unless the affected component becomes inoperable. It **does not** cover labor or labor-related charges.

This warranty specifically excludes liability for **indirect, incidental**, or consequential damages. Some states do not allow the exclusion or limitation of incidental or consequential damages, so the above exclusion may not apply to you. This warranty gives you specified legal rights, and you may have other rights that may vary from state to state.

For additional information regarding this warranty, or to place a warranty claim, contact the R.H. Peterson dealer where the product was purchased.

**TO REGISTER YOUR PRODUCT ONLINE GO TO: WWW.RHPETERSON.COM,
AND CLICK ON PRODUCT REGISTRATION. THANK YOU FOR YOUR PURCHASE.**

Quality Check			Date: _____		
Burner Orifices	Nat.	L.P.	Leak Test: _____	Model#: _____	
Main:	_____	_____	Burn Test: _____	Serial#: _____	
Other:	_____	_____	Gas Type: <u>Nat. / L.P.</u>	Air Shutter: _____	
				Inspector: _____	